

M3ネジ

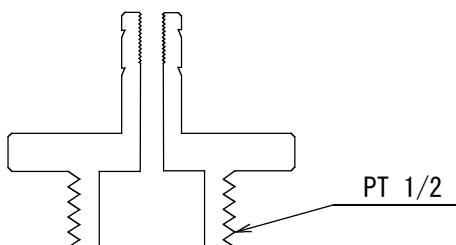

PT 1/2

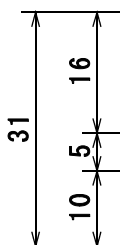
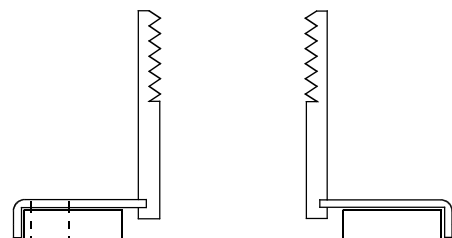
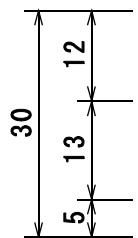
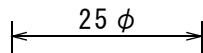
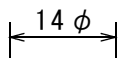

材質 スポンジ
(仮付用粘着テープ付)

3×5φ
(PCD 48φ)

※附属品：取付ビス3本付

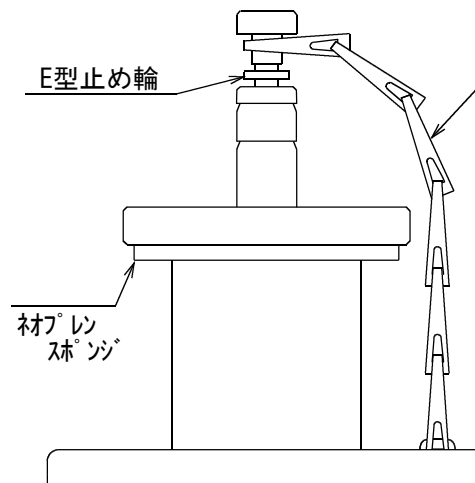
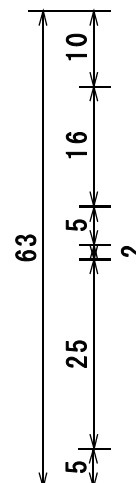
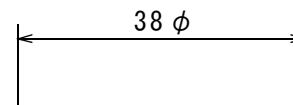

落下防止チェーン
(アダプター取付に長さ対応)

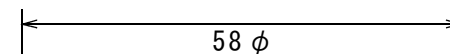

品名	オールステンレス製風量測定口				
材質	SUS 304				
型式	SUS-J-25			株式会社ジャパンアイビック	
承認	検図	製図	設計	尺度	FREE
				H	